

Wall mounted unit
Air Conditioning
Technical Data
FTXF-E



FTXF20E5V1B
FTXF25E5V1B
FTXF35E5V1B
FTXF42E5V1B

TABLE OF CONTENTS

FTXF-E

















1	Features	4
	FTXF-E	4
2	Specifications	5
3	Options	7
4	Dimensional drawings	8
5	Centre of gravity	9
6	Piping diagrams	10
7	Wiring diagrams	13
	Wiring Diagrams - Three Phase	13
8	Sound data	14
	Sound Power Spectrum	14
	Sound Pressure Spectrum	18

1 Features

1 - 1 FTXF-E

- > Seasonal efficiency values up to A++ in cooling
- > Onecta app (optional): control your indoor from any location with an app, via your local network or internet.
- > Quiet in operation down to 20 dBA
- > Choosing for an R-32 product, reduces the environmental impact with 68% compared to R-410A and leads directly to lower energy consumption thanks to its high energy efficiency



- | | | | | | | | | |
|--|--|---|---|--|--|--|---|--|
| 
Onecta app (optional) | 
Econo mode (25, 35 class) | 
Energy saving during standby mode (25, 35 class) | 
Fan only | 
Comfort mode (25, 35 class) | 
Powerful mode | 
Auto cooling-heating changeover | 
Indoor unit silent operation | 
Vertical auto swing |
| 
Auto fan speed | 
Fan speed steps (5 steps) | 
Dry programme | 
Air filter | 
24 hour timer | 
Infrared remote control | 
Auto-restart | 
Self diagnosis | |

2 Specifications

2 - 1 Specifications

Technical specifications				FTXF20E	FTXF25E	FTXF35E	FTXF42E	
Power input	Cooling	Nom.	kW	0.023		0.029	0.040	
	Heating	Nom.	kW	0.023		0.029	0.040	
Casing	Colour			White				
Dimensions	Unit	Height	mm	286				
		Width	mm	770				
		Depth	mm	225				
	Packed unit	Height	mm	305				
		Width	mm	830				
		Depth	mm	360				
Weight	Unit		kg	8.00		8.50	9.00	
	Packed unit		kg	10		11		
Packing	Weight			kg				
Heat exchanger	Length			mm				
	Rows	Quantity		2				
	Fin pitch			mm				
	Stages	Quantity		18				
	Tube type			ø5 Hi-XB				
	Fin	Type		ML fin (Multi louver)				
	Heat exchanger 2	Length			mm		-	600
		Rows	Quantity		-			
Fin pitch			mm					
Stages		Quantity		-				
Fan	Type			Cross flow fan				
	Quantity			1				
Fan	Air flow rate	Cooling	High	m ³ /min	9.8	10.0	11.5	12.6
				cfm	346	353	406	450
			Medium	m ³ /min		8		9
			cfm	286	289	298	310	
		Low	m ³ /min	6.0	6.2	6.4	6.9	
			cfm	212	219	226	243	
	Heating	High	m ³ /min		4.3		4.4	4.9
			cfm		152		155	173
		Medium	m ³ /min	8.3	8.4	8.6	8.8	
			cfm	293	297	302	310	
		Low	m ³ /min	6.2	6.4	6.5	6.7	
			cfm	219	226	230	236	
Fan	Air flow rate	Heating	Low	m ³ /min	6.2	6.4	6.5	6.7
				cfm	219	226	230	236
Fan	Air flow rate	Heating	Silent operation	m ³ /min		5.3		5.2
				cfm		187		183
Fan motor	Model			DFD03C1VB				
	Speed	Steps			5 + silent, + auto			
		Cooling	High	rpm	1,000	1,020	1,140	1,250
	Medium			rpm	830		870	1,010
	Low			rpm	660		700	780
	Silent operation			rpm	530	540	600	
	Heating		High	rpm	1,040		1,140	1,250
			Medium	rpm	880		930	1,010
		Low	rpm	710		760	780	
	Silent operation			rpm	610		650	
	Output	Rated			W			
		Sound power level	Cooling			53.0	54.0	
Heating			55.0		56.0	59.0		
Sound pressure level	Cooling	High	dB(A)	39.0	40.0	43.0	45.0	
			Medium	dB(A)	33.0		34.0	36.0
		Low	dB(A)	25.0	26.0	27.0	30.0	
			Silent operation			dB(A)	20.0	
	Heating	High	dB(A)	39.0	40.0		44.0	
			Medium	dB(A)	34.0		35.0	34.0
		Low	dB(A)	28.0		29.0	28.0	
			Silent operation			dB(A)	21.0	
Piping connections	Liquid	OD		mm				
		Gas		mm				
	Drain			mm				
	Heat insulation			Both liquid and gas pipes				
Air filter	Type			Removable / washable				
Air direction control				Right, Left, Horizontal, Downward				
Temperature control				Microcomputer control				
Control systems	Infrared remote control			ARC470A1				
	Wired remote control			BRC073A1				

Standard accessories: Installation manual;Quantity: 1;

Standard accessories: Operation manual;Quantity: 1;

2 Specifications

2 - 1 Specifications

Standard accessories: Infrared remote control;Quantity: 1;

Standard accessories: AAA dry-cell batteries;Quantity: 2;

Standard accessories: Remote control holder;Quantity: 1;

Standard accessories: Mounting plate;Quantity: 1;

Standard accessories: Indoor unit fixing screws;Quantity: 2;

Standard accessories: General safety precautions;Quantity: 1;

2

Electrical specifications		FTXF20E	FTXF25E	FTXF35E	FTXF42E
Power supply	Phase			1~	
	Frequency	Hz		50	
	Voltage	V		220-440	

Cooling: indoor temp. 27°CDB, 19°CWB; outdoor temp. 35°CDB; equivalent piping length: 5m; level difference: 0m |

Heating: indoor temp. 20°CDB; outdoor temp. 7°CDB, 6°CWB; equivalent refrigerant piping: 5m (horizontal) |

See separate drawing for electrical data

4 Dimensional drawings

4 - 1 Dimensional Drawings

4

ATXF-E
FTXF-E

The $\cdot \text{---} \cdot$ mark shows the piping direction.

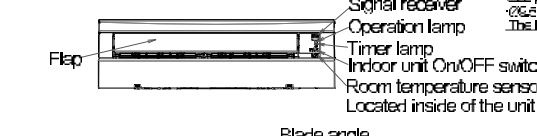
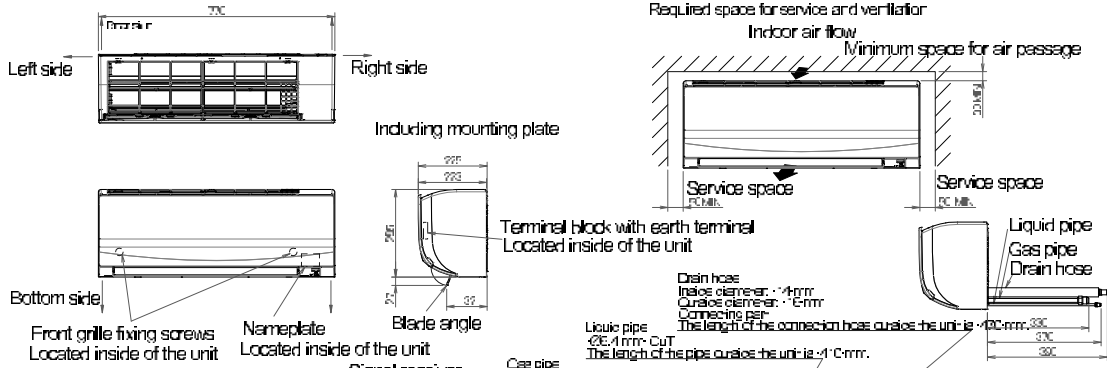

Signal transmitter

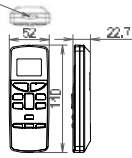

Wireless remote control

(ARC470A1)

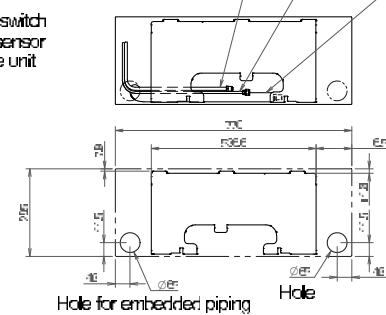
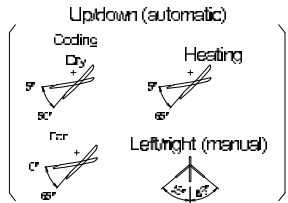

Standard location of holes in the wall

3D113368

5 Centre of gravity

5 - 1 Centre of Gravity

ATXP-N
ATXF-E
FTXF-E

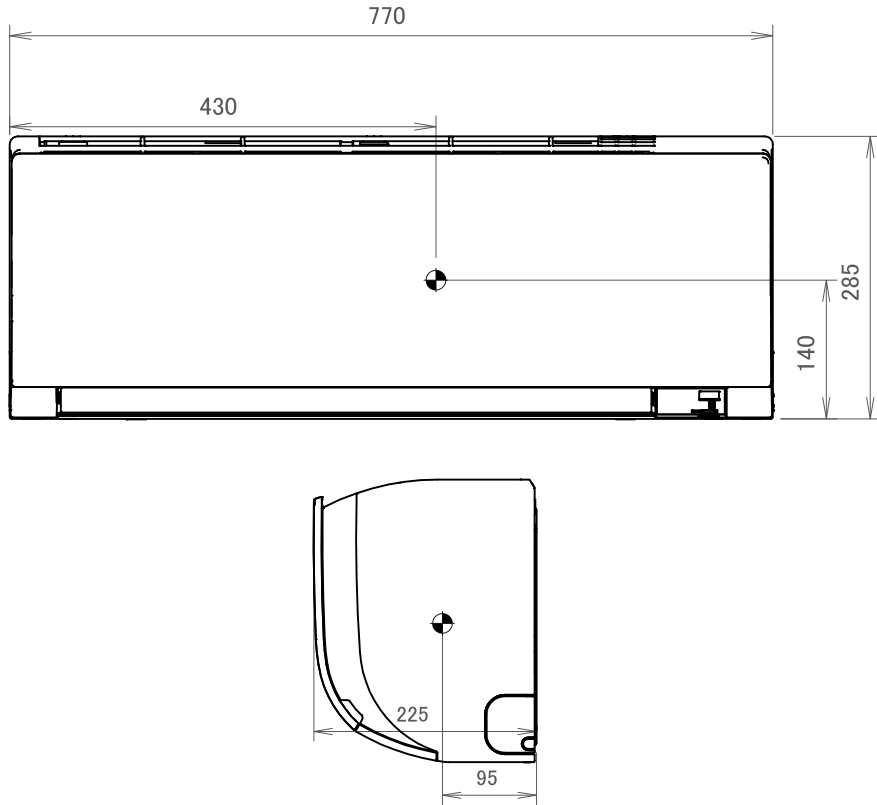

4D094235D

6 Piping diagrams

6 - 1 Piping Diagrams

6

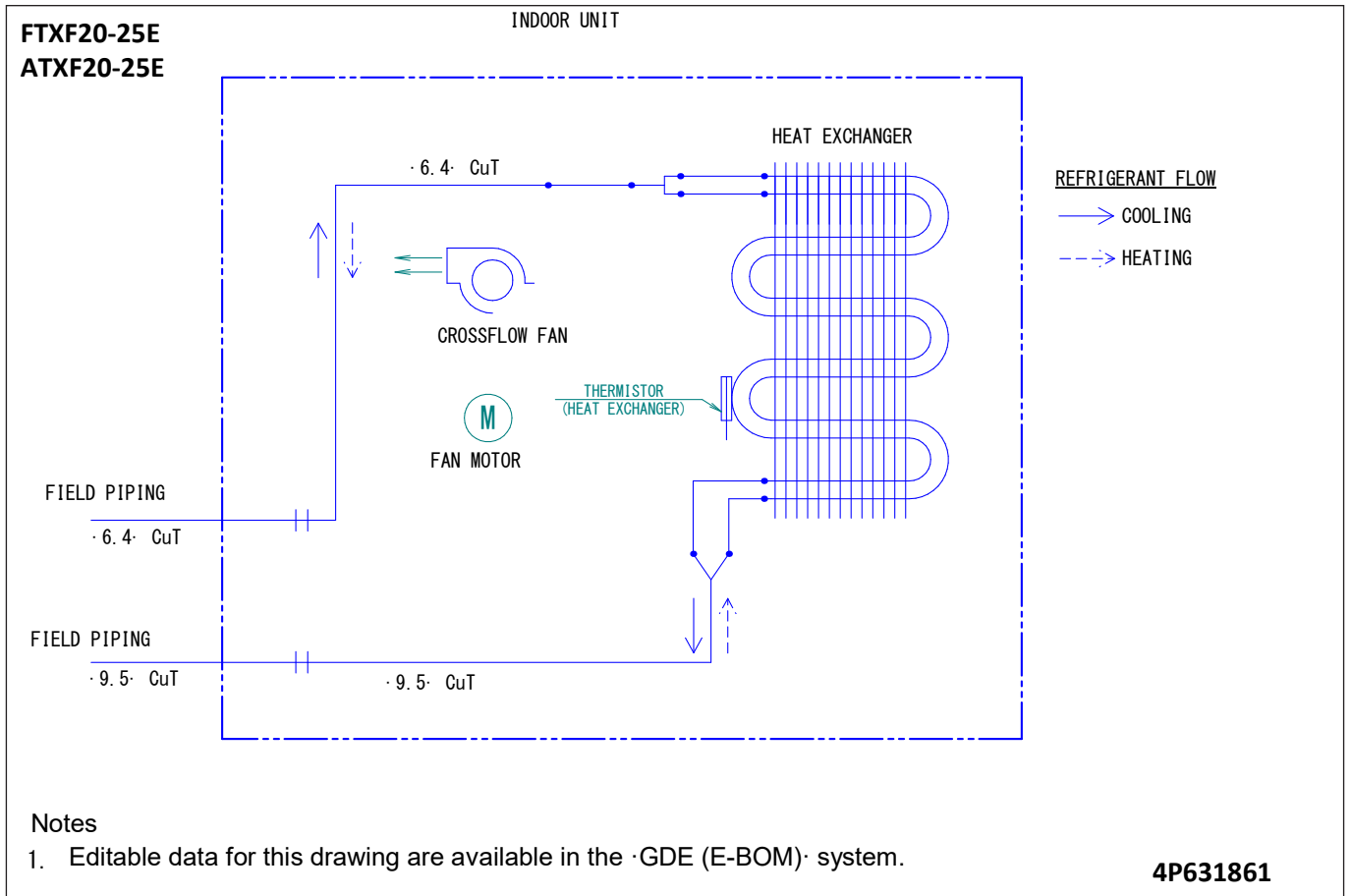

6 Piping diagrams

6 - 1 Piping Diagrams

ATXP20-25N

ATXF35E

FTXF35E

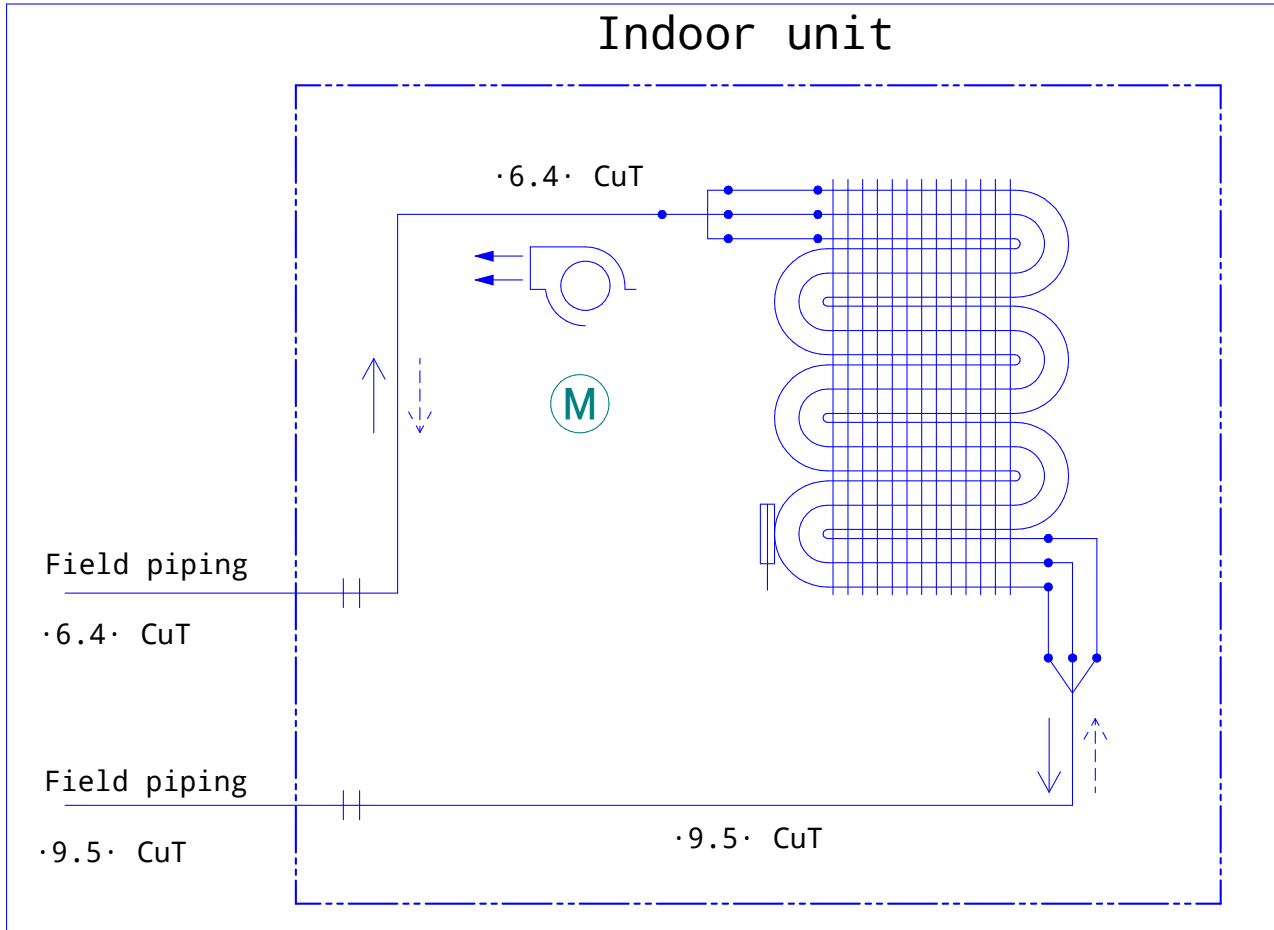



Refrigerant flow

→ Cooling

- - -> Heating

 Crossflow fan

 Fan motor

 Thermistor (heat exchanger)

 Heat exchanger

4D139891

6 Piping diagrams

6 - 1 Piping Diagrams

6

ATXF42E
FTXF42E

INDOOR UNIT

REFRIGERANT FLOW

—> COOLING

-> HEATING

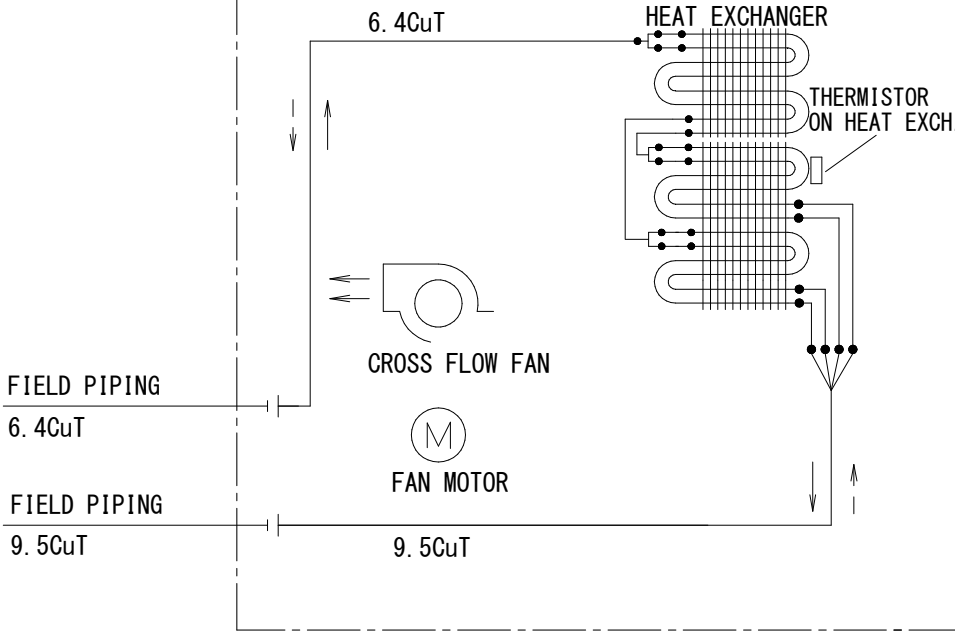

3D130682

8 Sound data

8 - 1 Sound Power Spectrum

8

ATXF20E
FTXF20E

Cooling mode

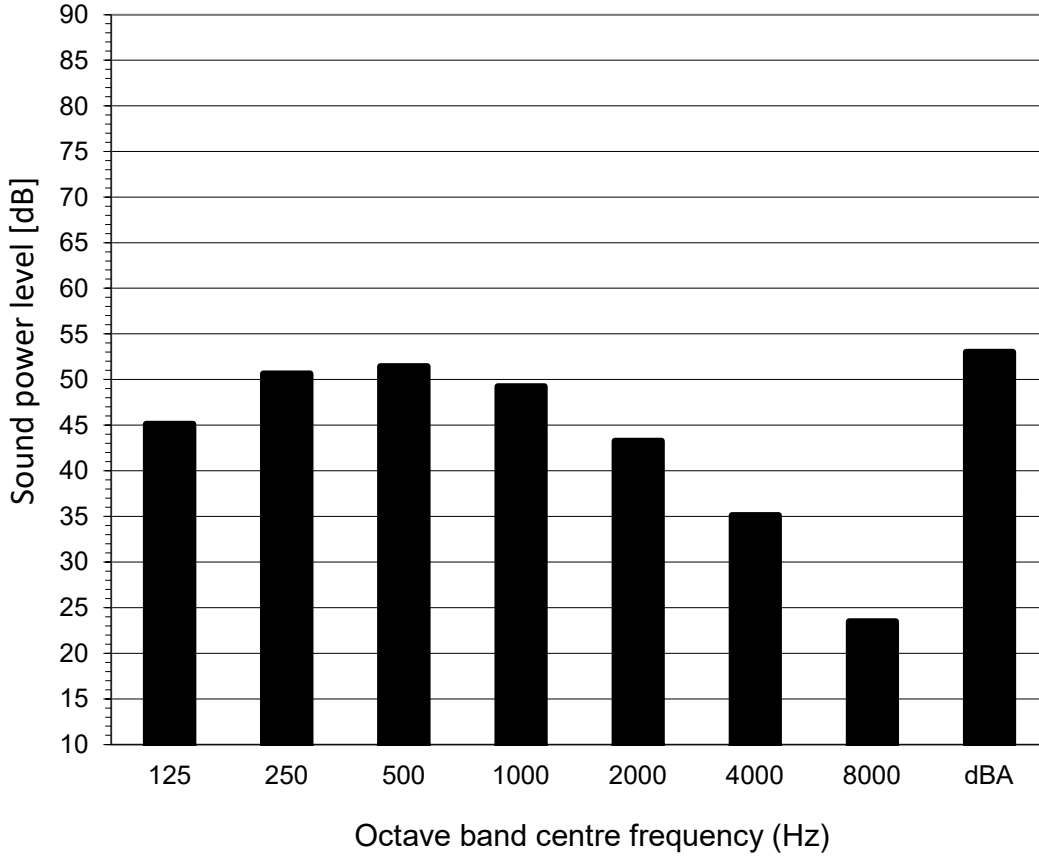

Heating mode

Fan Speed
 High

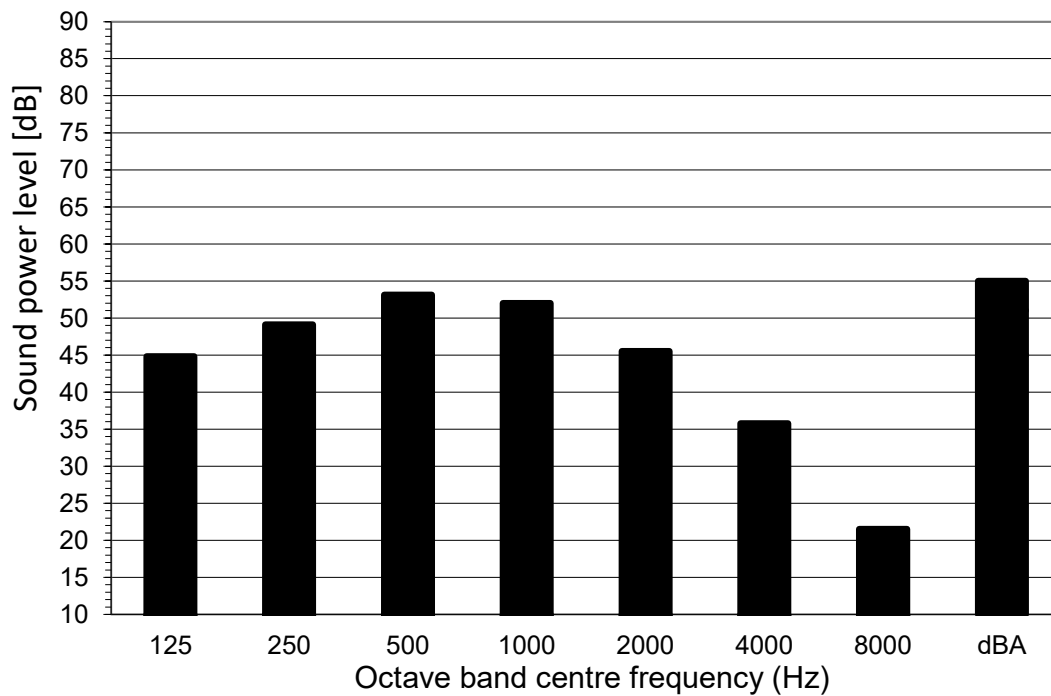

4D131985

8 Sound data

8 - 1 Sound Power Spectrum

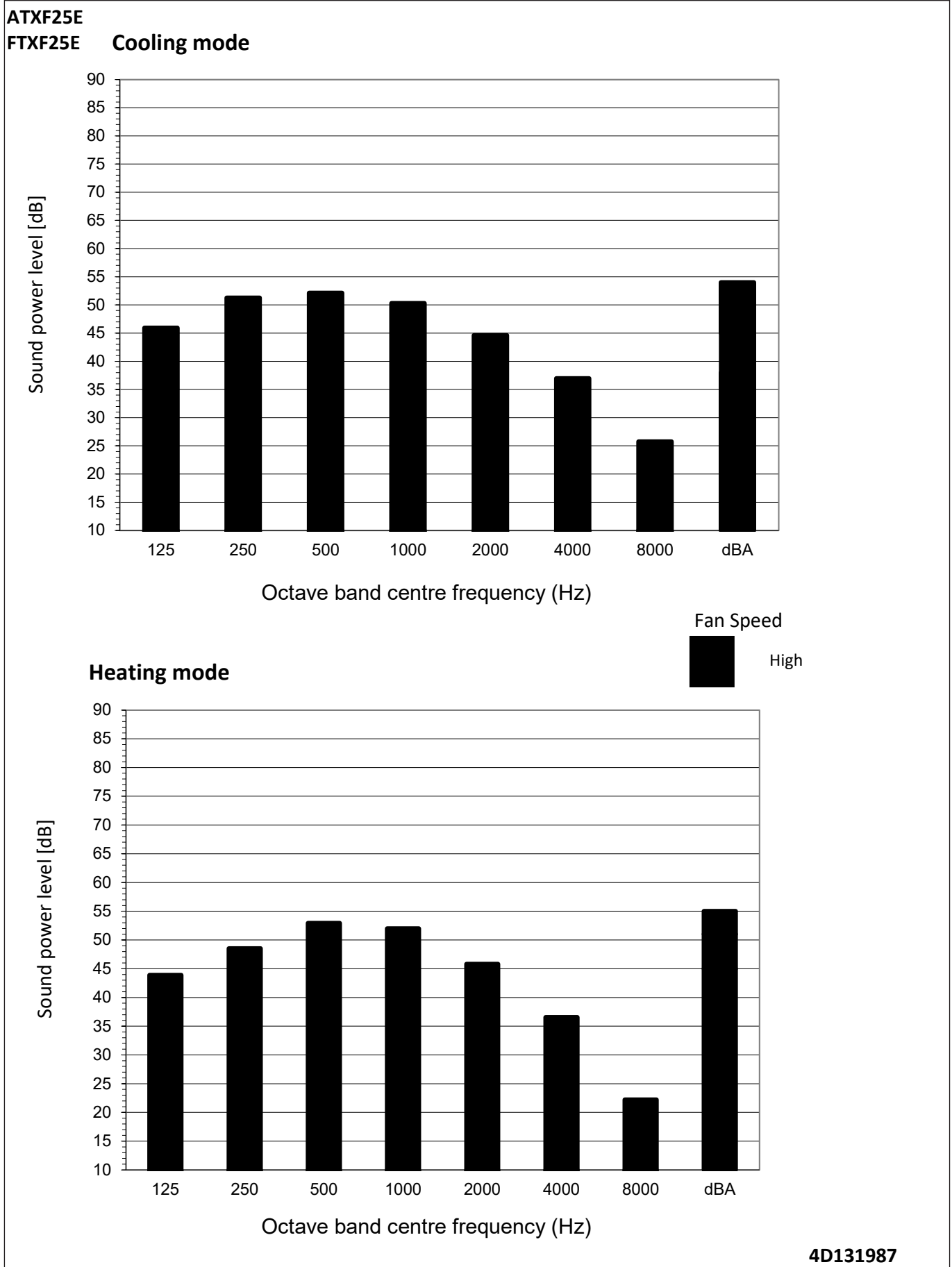

8 Sound data

8 - 1 Sound Power Spectrum

8

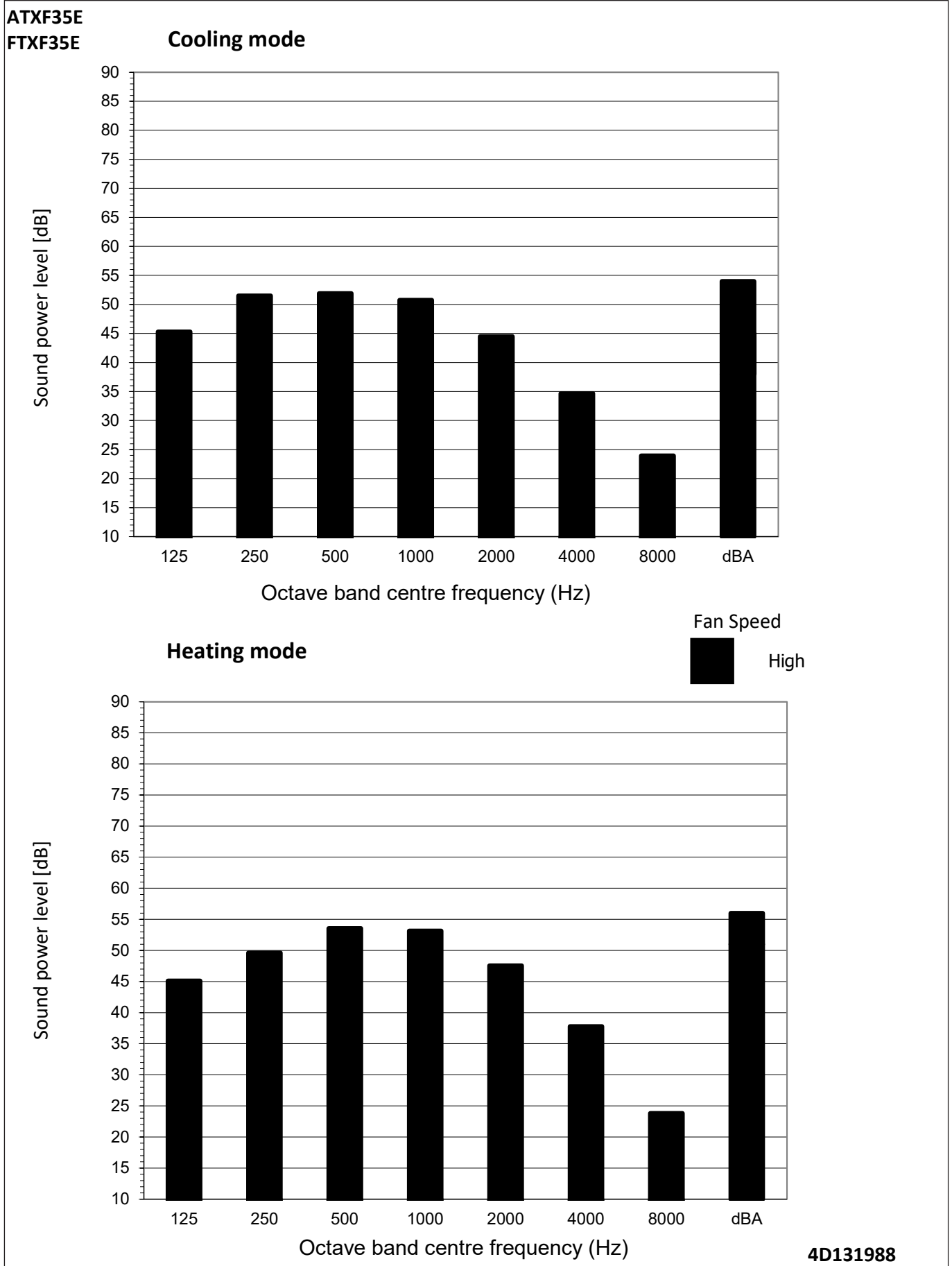

8 Sound data

8 - 1 Sound Power Spectrum

ATXF42E

FTXF42E

Cooling mode

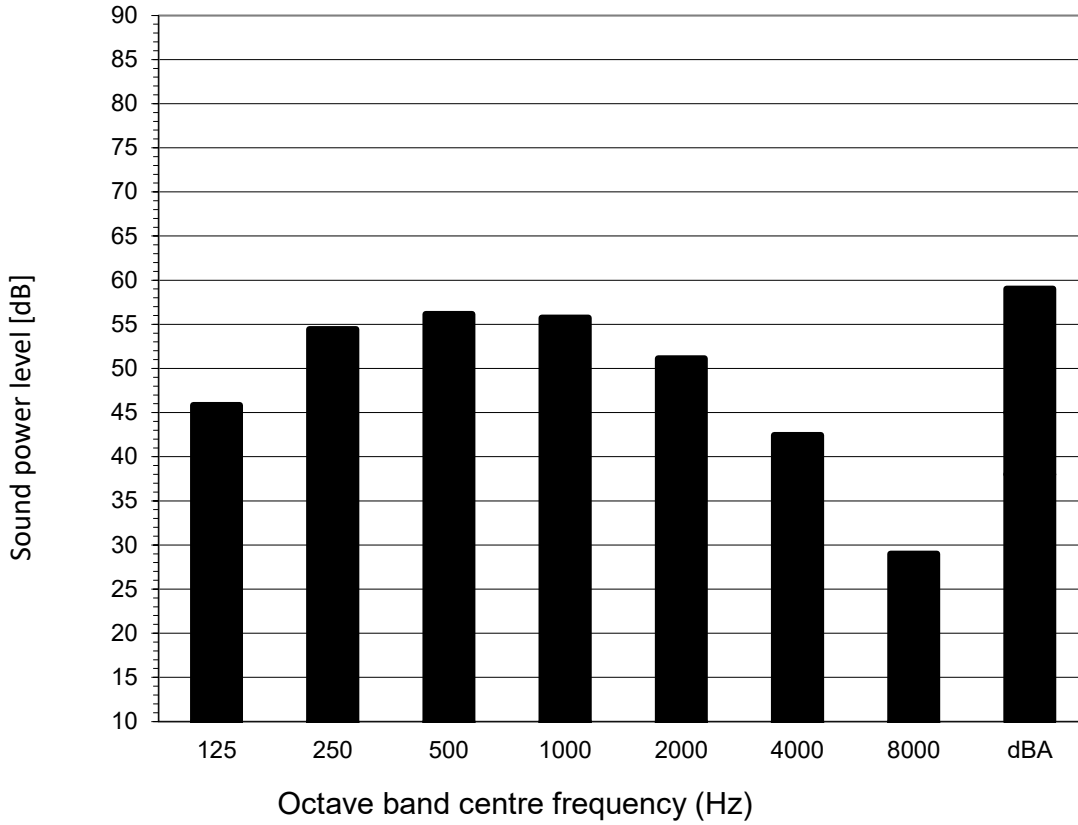

Heating mode

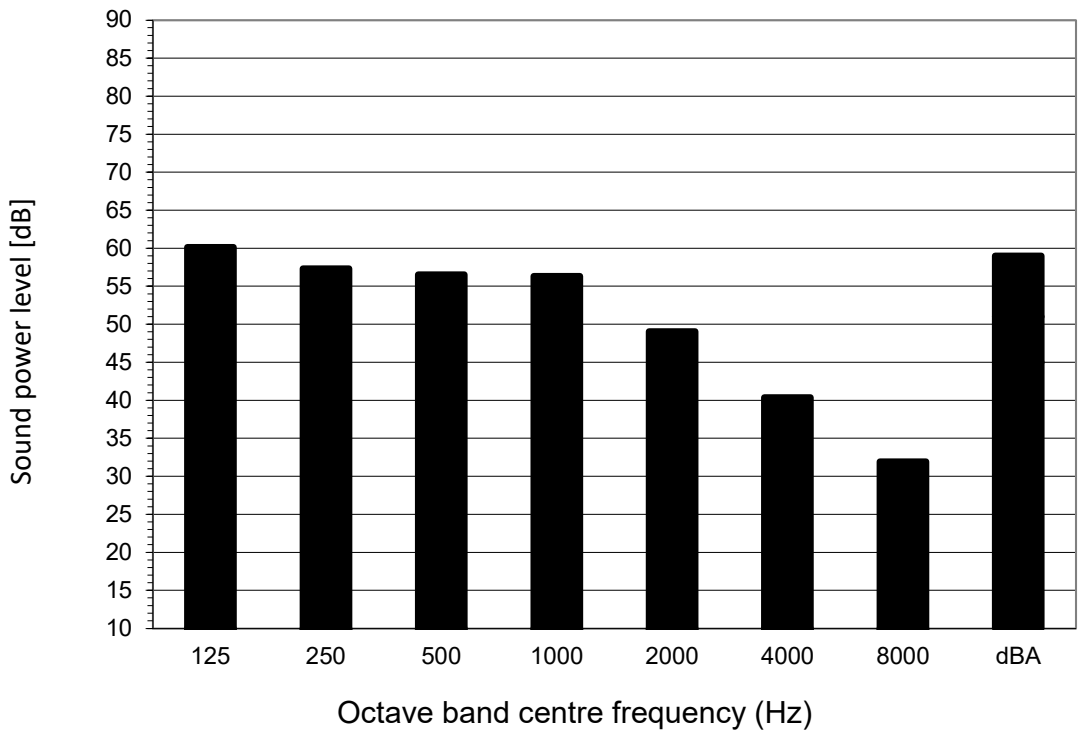

4D131989

8 Sound data

8 - 2 Sound Pressure Spectrum

8

ATXF20E
FTXF20E

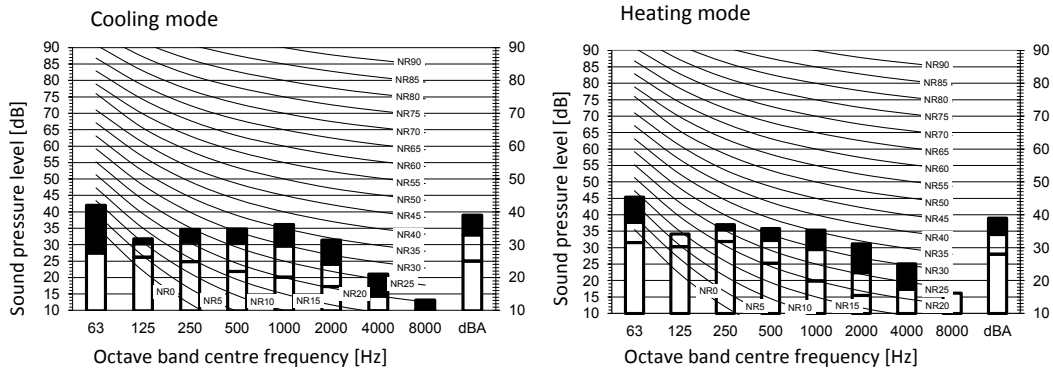

Legend

dBA = A-weighted sound pressure level (A scale according to IEC).

A Scale Fan speed
 B High
 C Medium
 D Low

Cooling		Total dB	
A	B	C	D
dBA	39	33	25

Heating		Total dB	
A	B	C	D
dBA	39	34	28

Notes

Location of microphone

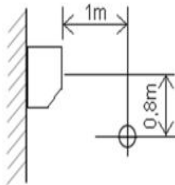

- Operating conditions: power source 220-240 V/220 V 50/60 Hz; JIS standard
- Background noise already taken into account.
- Operating noise varies depending on operation and ambient conditions.
- The operation noise measuring method is in accordance with JISC9612.
- Measuring location: anechoic chamber

3D108789A

ATXF25E
FTXF25E

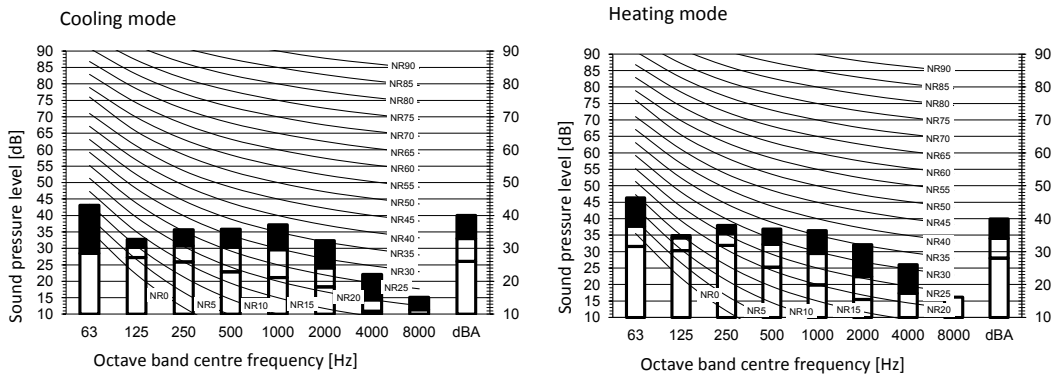

Legend

dBA = A-weighted sound pressure level (A scale according to IEC).

A Scale Fan speed
 B High
 C Medium
 D Low

Cooling		Total dB	
A	B	C	D
dBA	40	33	26

Heating		Total dB	
A	B	C	D
dBA	40	34	28

Notes

Location of microphone

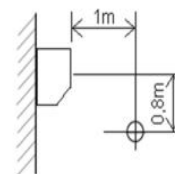

- Operating conditions: power source 220-240 V/220 V 50/60 Hz; JIS standard
- Background noise already taken into account.
- Operating noise varies depending on operation and ambient conditions.
- The operation noise measuring method is in accordance with JISC9612.
- Measuring location: anechoic chamber

3D108790A

8 Sound data

8 - 2 Sound Pressure Spectrum

ATXF35E
FTXF35E
ATXP35N

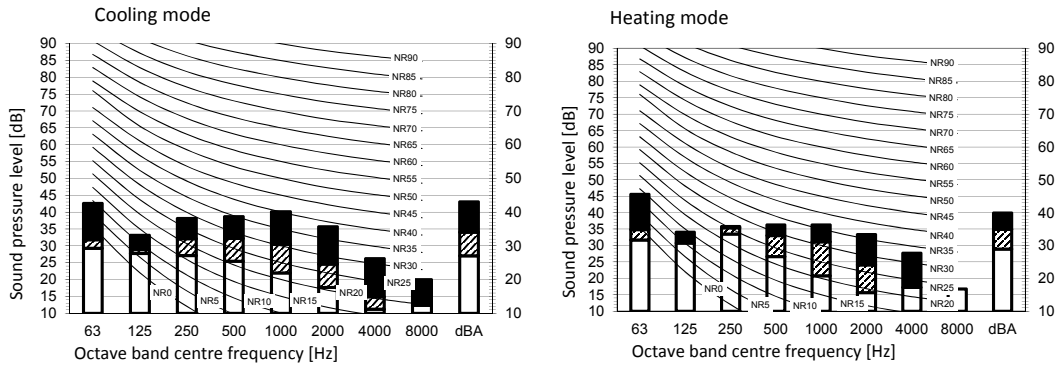

Legend

dBA = A-weighted sound pressure level (A scale according to IEC).

A Scale Fan speed
 B High
 C Medium
 D Low

Cooling		Total dB	
A	B	C	D
dBA	43	34	27

Heating		Total dB	
A	B	C	D
dBA	40	35	29

Notes

Location of microphone

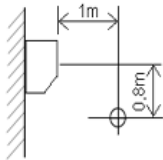

- Operating conditions: power source 220-240 V/220 V 50/60 Hz; JIS standard
- Background noise already taken into account.
- Operating noise varies depending on operation and ambient conditions.
- The operation noise measuring method is in accordance with JISC9612.
- Measuring location: anechoic chamber

3D108791A

ATXF42E
FTXF42E

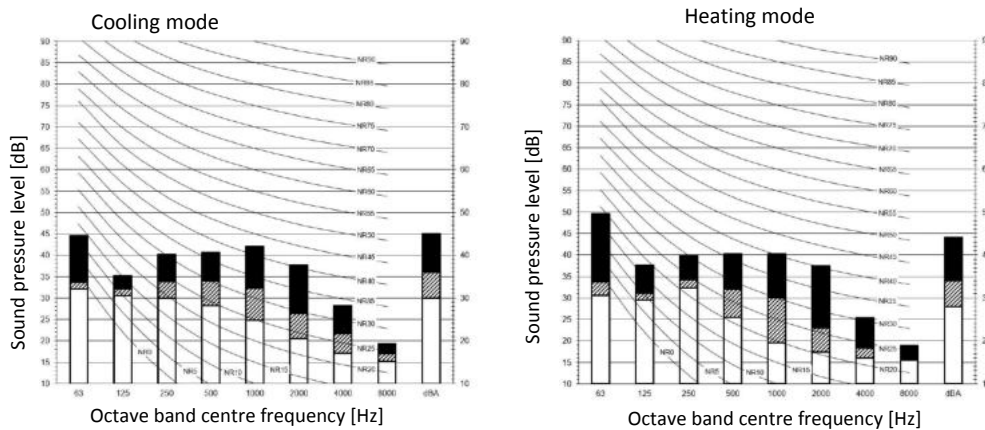

Legend

dBA = A-weighted sound pressure level (A scale according to IEC).

A Scale Fan speed
 B High
 C Medium
 D Low

Cooling		Total dB	
A	B	C	D
dBA	45	36	30

Heating		Total dB	
A	B	C	D
dBA	44	34	28

Notes

Location of microphone

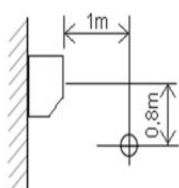

- Operating conditions: power source 220-240 V/220 V 50/60 Hz; JIS standard
- Background noise already taken into account.
- Operating noise varies depending on operation and ambient conditions.
- The operation noise measuring method is in accordance with JISC9612.
- Measuring location: anechoic chamber

3D144462

Daikin Europe N.V. Naamloze Vennootschap · Zandvoordestraat 300 · 8400 Oostende · Belgium · www.daikin.eu · BE 0412 120 336 · RPR Oostende (Responsible Editor)

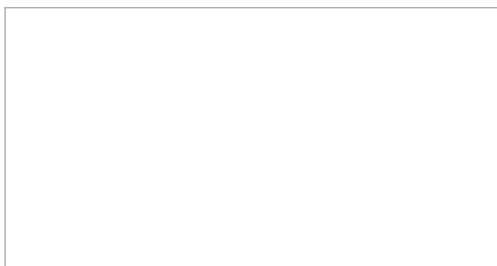

Daikin Europe N.V. participates in the ECP programmes for Fan Coil Units and Variable Refrigerant Flow systems. Daikin Applied Europe S.p.A. participates in the ECP programmes for Liquid Chilling Packages and Hydronic Heat Pumps. Check ongoing validity of certificate: www.eurovent-certification.com

EEDEN23

01/2023



The present leaflet is drawn up by way of information only and does not constitute an offer binding upon Daikin Europe N.V. Daikin Europe N.V. has compiled the content of this leaflet to the best of its knowledge. No express or implied warranty is given for the completeness, accuracy, reliability or fitness for particular purpose of its content and the products and services presented therein. Specifications are subject to change without prior notice. Daikin Europe N.V. explicitly rejects any liability for any direct or indirect damage, in the broadest sense, arising from or related to the use and/or interpretation of this leaflet. All content is copyrighted by Daikin Europe N.V.